

KOHLER® Faucets

14" rainhead with Katalyst® air-induction technology, 2.5 gpm
K-13691

Features

- Single-function rainhead.
- MasterClean™ sprayface features an easy-to-clean surface that withstands mineral buildup.
- Optimized sprayface for maximum performance.
- 2.5 gpm (9.5 lpm) maximum flow rate.

Material

- Solid-brass construction for durability and reliability.

Technology

- Katalyst® air-induction technology infuses water with air, creating bigger drops for a more powerful spray.

Installation

- 1/2 -14 NPT connection.

Recommended Products/Accessories

K-23723 Faucet cleaner



Codes/Standards

ASME A112.18.1/CSA B125.1







DOE - Energy Policy Act 1992

KOHLER® Faucet Lifetime Limited Warranty

See website for detailed warranty information.

Available Colors/Finishes

Color tiles intended for reference only.

Color	Code	Description
	CP	Polished Chrome
	SN	Vibrant® Polished Nickel
	PGD	Vibrant® Moderne Polished Gold
	BN	Vibrant® Brushed Nickel
	BV	Vibrant® Brushed Bronze
	2MB	Vibrant® Brushed Moderne Brass
	TT	Vibrant Titanium

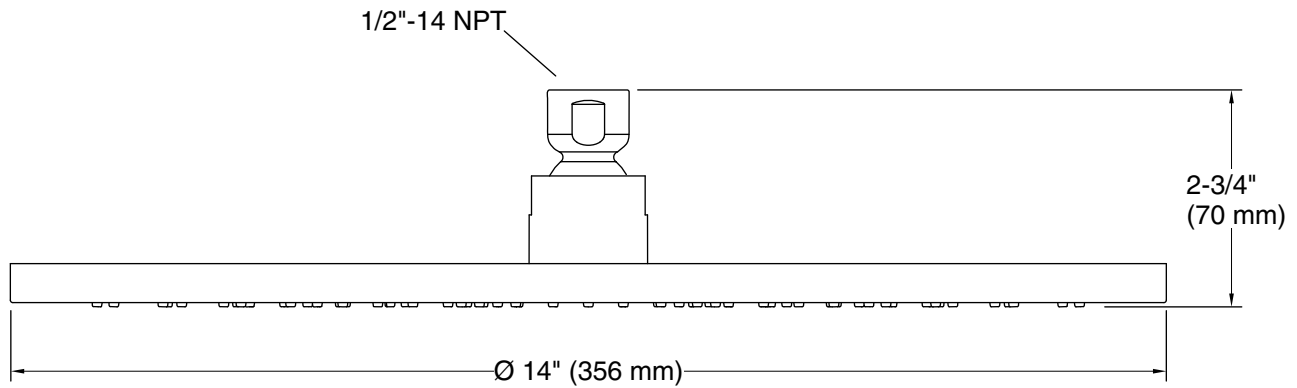

Technical Information

All product dimensions are nominal.

Showerhead/Body Spray:

Rated maximum flow: 2.5 gal/min (9.5 l/min)

Notes

Install this product according to the installation instructions.